

GWE



Part I: Setup and use the GWE

1	Table of Contents	
2	Preface	2
3	History	3
4	Setup in QEF and RA	4
4.1	In RA.....	4
4.2	Setting up GWE in QLM.....	5
4.2.1	Import standard workflows in repository	5
4.2.2	Synchronize objects from previous QualiWare version	6
4.3	Setup mail for GWE.....	8
5	Change Management in QLM and QEP	11
5.1	GovernanceTransition	11
5.2	Governance History.....	13
5.3	Governance Features	14
6	Table of Figures	15

2 Preface

The primary target for this documentation are superusers of QualiWare, consultants and technical consultants.

GovernanceWorkflowEngine (GWE) is used for controlling the flow of diagrams/objects in the QualiWare both in backend (QLM) and frontend (QEP).

The document is divided into three parts (different documents):

- Part I: Setup and use of the governance workflow in QLM and QEP**
- Part II: Walkthrough of the different templates related to the GWE**
- Part III: Elaboration of the different governance workflows**

Part III goes through different workflows where availability is depended on license(s). Below is a distribution of licenses and their respective workflows.

Collaboration license:

- Change Management
- ChangeRequest
- Document (QDM)
- Problem

CAI

- Audit
- Corrective action
- Non conformance

Compliance license (to obtain this a CAI license is required):

- Complaint
- Contract
- Incident
- Accident
- Asset
- Compliance

For more on how the licenses are structure and what you get besides workflows please contact our sales department (Salg@Qualiware.dk/Sales@Qualiware.com).

Information about how to create a good governance model based on best practices and research, please contact our Center of Excellence (DKCenterofExcellence@QualiWare.com).

3 History

Document Revision	Date	Author	Changes
1	25-07-16	Loa Lind	First draft
2	30-10-17	Casper Voigt	Removed text covering old functionality

4 Setup in QEF and RA

4.1 In RA

You create a repository (for more detail on setting up repositories see other documentation "5. Repository Administrator.PDF"). In RA the GWE is enabled as an Addon to the repository.

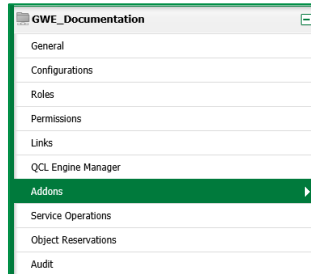

Figure 1: Repository setup menu in RA

You choose the Governance Workflow Engine tab, and click the edit button.

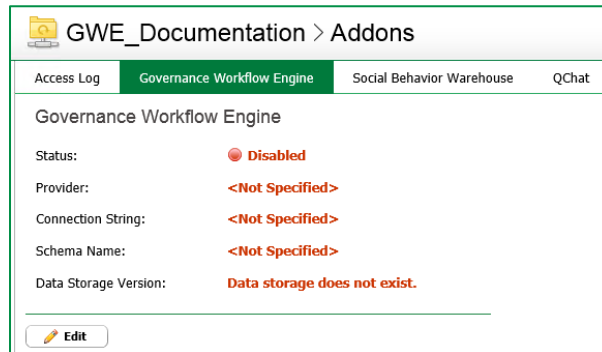

Figure 2: Before creating the GWE database

If "Generate Settings*" is used the default values for the GWE repository will be to create the schema in the same database as the first ever created repository.

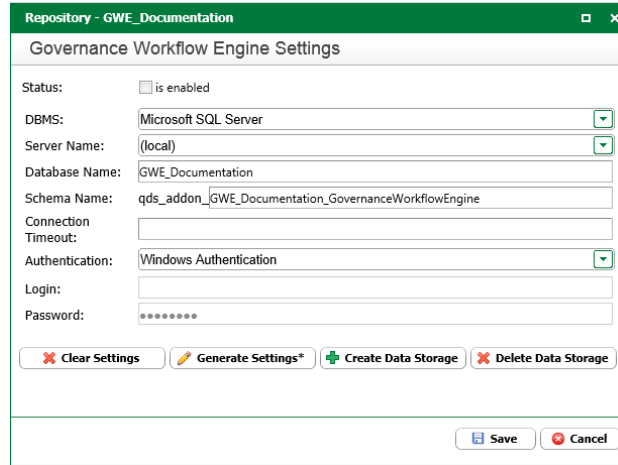

Figure 3: After pressing "Generate Settings*" values are inserted automatically

4.2 Setting up GWE in QLM

4.2.1 Import standard workflows in repository

We have several standard workflows as explained in the preface.

You will find the standard workflows in the Compliance\ExportFiles or Collaboration\ExportFiles folder in Models located on the drive you installed for QLM.

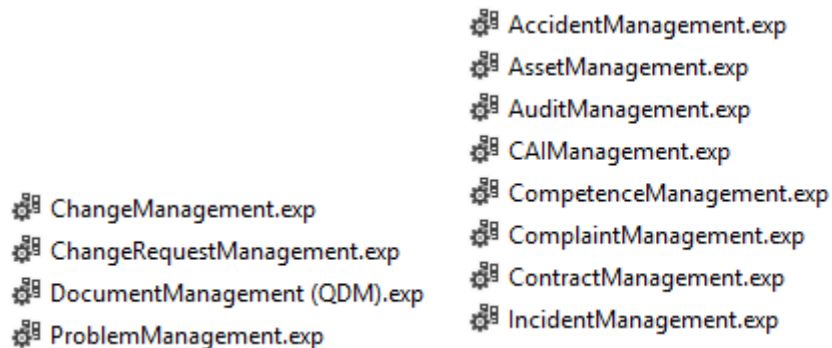

Figure 4: On the left are the workflows for Collaboration and on the right are Compliance workflows

After importing one of the workflows (or all) you will find the relevant templates under the Governance button.

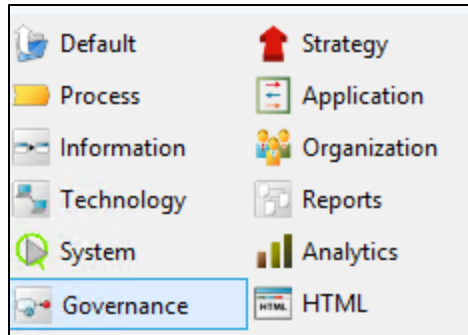

Figure 5: QLM buttons

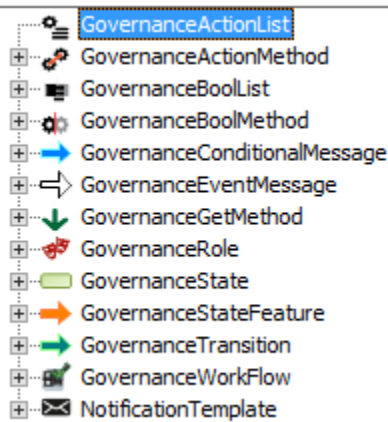

Figure 6: The relevant templates for configuring GWE

4.2.2 Synchronize objects from previous QualiWare version

If you have objects (/diagrams) from a previous QualiWare version, you will have to synchronize the workflow with the repository in order for the objects to be registered by the GWE.

1. For the specific workflow open the form dialog
2. Find the Maintenance tab and press the "From Workflow" button.
3. Wait until there is no longer a check mark in Running above the button.

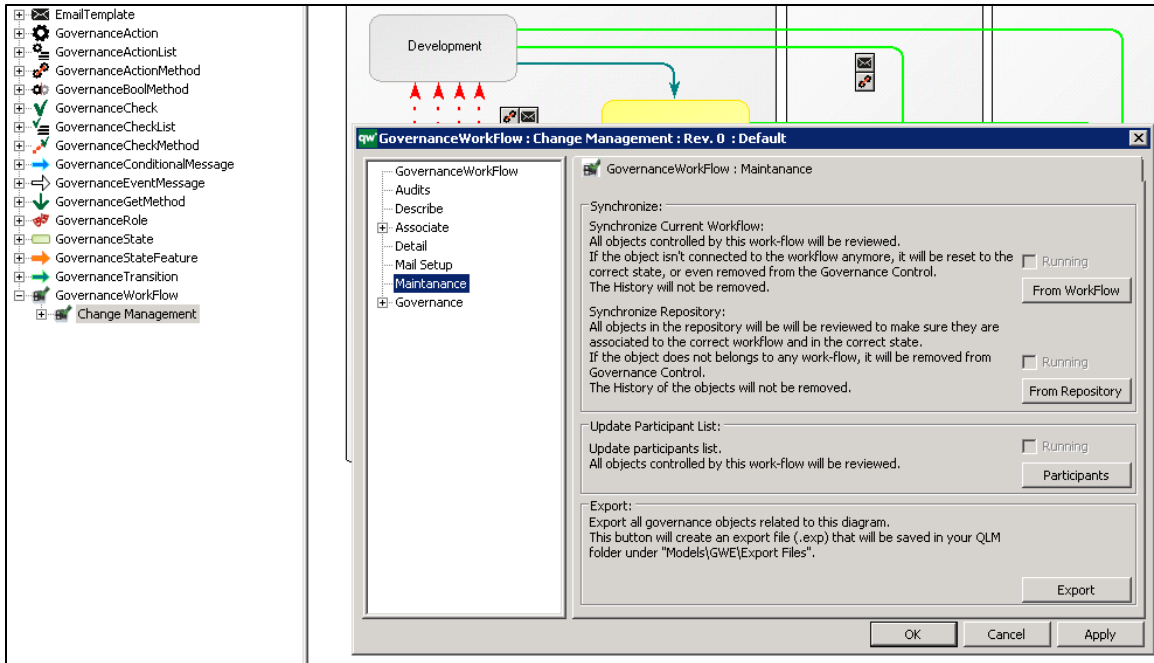

Figure 7: The Synchronize buttons for Change Management GovernanceWorkFlow

You should now be able to see the Governance Status tab with the State set to the correct status.

If its State is "Object Legacy", then it means that the GWE has not synchronized the object completely.

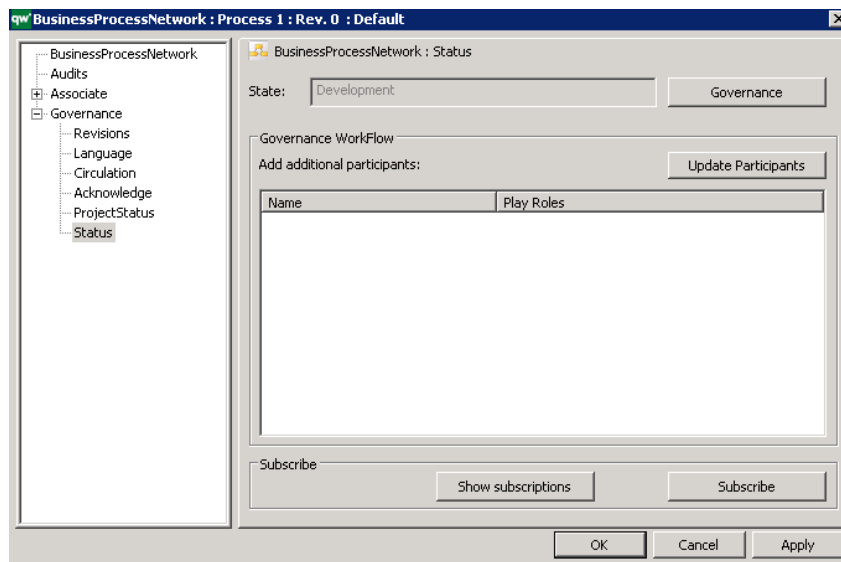

Figure 8: Governance tab for a BusinessProcessNetwork (it is the same for every object registered by the GWE)

You also need to synchronize the GWE from RA if you have legacy data.

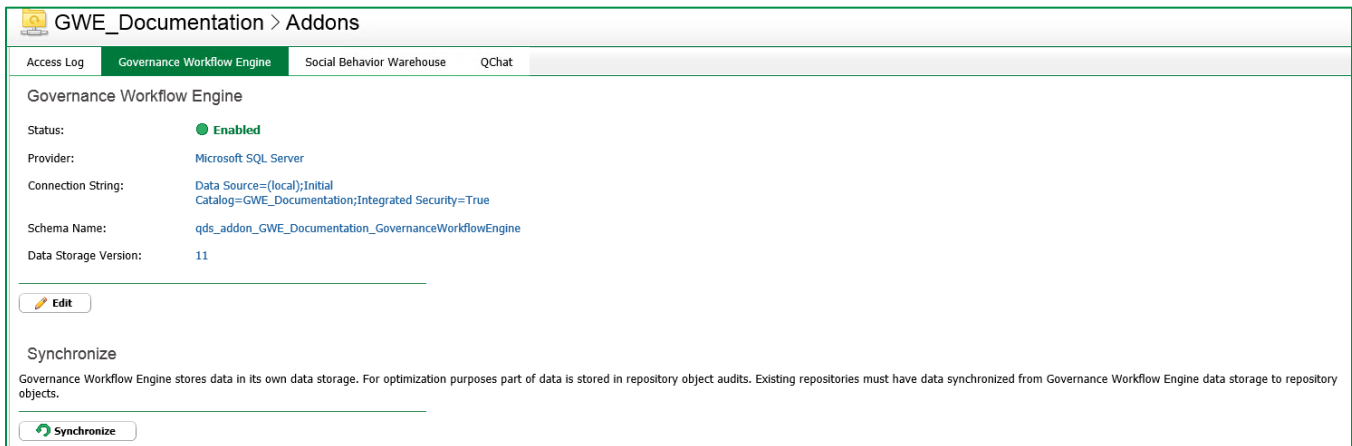

Figure 9: Synchronize the GWE

4.3 Setup mail for GWE

Mail for the GWE is first setup in QEF.

You can setup several mail servers – this is often only necessary if you have a mail server that only can send to specific users (domains).

The SMTP Server Settings dialog requires:

Dialog field	Description
Name	recognizable name of the mail server (important if several mail setups are created)
Host	what is the host of the mail server
Port	which port can be used for sending mails
Authentication method	is there need for special authentication (negotiate, ntlm, digest, login)
Login as	Is there a need for an account to login to get access to the mail server
Test settings	'to address' is made visible and a standard email is sent

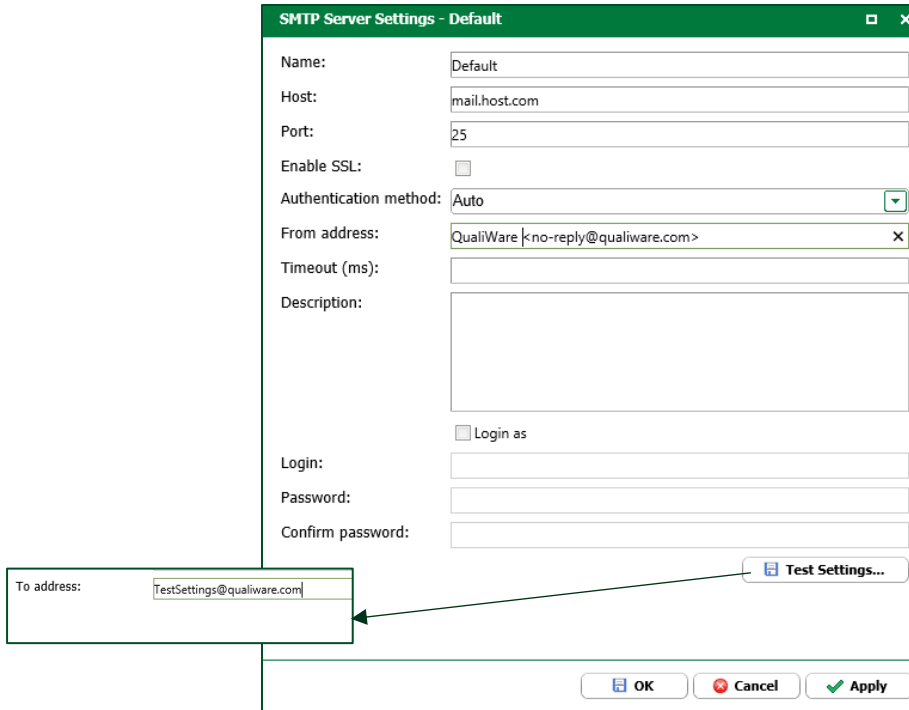

Figure 10: Dialog for setting up mail server

In QLM, after importing the standard workflow(s), you need to add the mail setting to the workflow.

Either click the "Select..." button or right-click and click "Select configuration...". Then choose the Mail you setup in QEF.

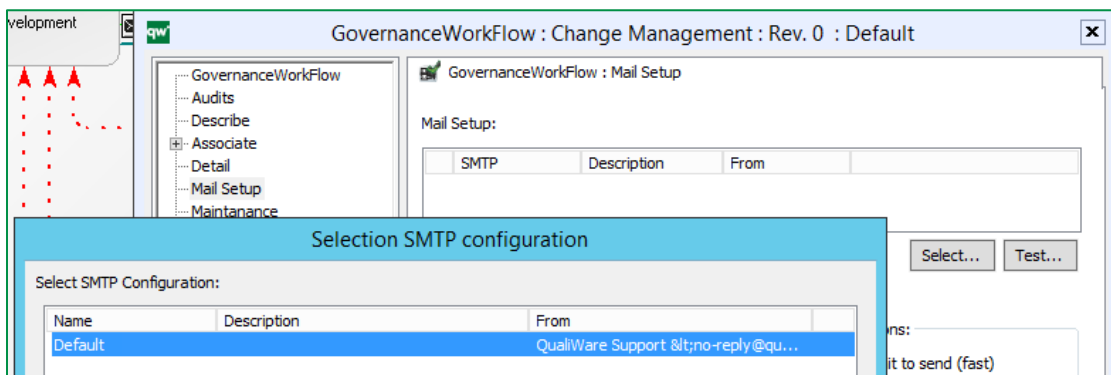

Figure 11: Setup the mail for the GovernanceWorkFlow

If you only want emails to be sent to specific domains you can filter them on the list below.

In regards to Delivery options you have:

- "Do not wait to send (fast)": which means that emails (notifications) will be sent immediately. If something goes wrong in sending the email, and you haven't set up

the QCL Engine service "EmailSender" in the HTMLPublisher, then the email will never be sent.

- "Use 'HTTP Sender Service'": will only send emails if the *EmailSender* QCL service has been added to the HTMLPublisher.

In the HTMLPublisher for *EmailSender* you can set how often emails should be send out.

The screenshot shows a configuration window with two main sections. On the left, under "Email Domain Filter:", there is a "Select Domain" button and a text input field containing "qualiware.com". On the right, under "Delivery Options:", there are two radio buttons. The first is "Do not wait to send (fast)" which is selected. The second is "Use 'HTTP Sender Service'" which is unselected.

Figure 12: Filter on email domains and the two delivery options

The screenshot shows the "HTMLPublisher: QualiWare Enterprise Publisher : Rev. 0 : Default Modified" window. The left sidebar shows a tree view with "Governance" selected. The main area is titled "HTMLPublisher : Add ons" and contains several sections. The "Addons:" section has checkboxes for "QualiWare Chat", "Social Behavior Warehouse", and "Governance Workflow Engine" (which is checked). The "Remote repositories" section has a table with columns: Repository, Repository ID, Web Applica..., Follow links, and Target. The "QCL Engine Services:" section contains a table with the following data:

Name	User	Configuration	Engine ID	Status	Parameters (optional)
EmailSender	SomeUser	BaseConfiguration	5856f415-2b15-48b9-acf4-1e7...	Running	Timer=01:00;Frequency=Daily;

At the bottom of the window are buttons for "Publish", "OK", "Cancel", and "Apply".

Figure 13: QCL Engine Service "EmailSender"

5 Change Management in QLM and QEP

The following section contains a description of how to use the GovernanceWorkflow in QLM and on the web (more specific details will be explained in chapters to come).

This description will be applicable for any GovernanceWorkflow.

N.B. When an object is managed by some GovernanceWorkflow it will have a state. If the object is registered by the correct GovernanceWorkflow, but has not yet been registered in a state, it will have the state "Legacy GWE Object".

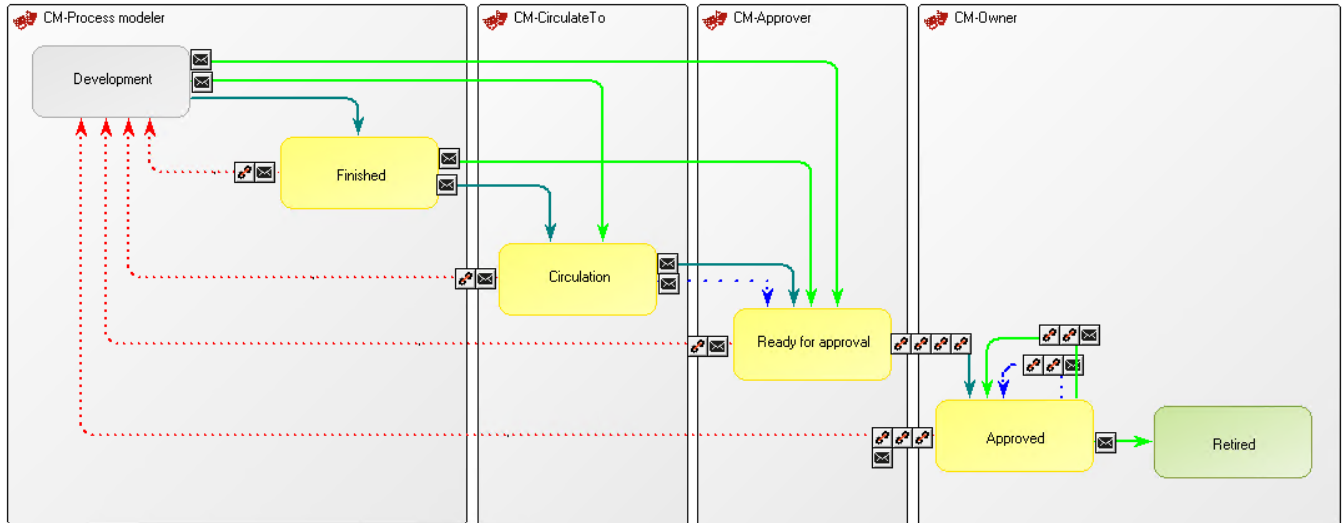

Figure 14: The Change Management process

QualiWare's Change Management workflow is used for controlling the lifecycle of an object going from development to approve (as shown above). When using private workspaces, approved objects can either be automatically or manually promoted to the base configuration.

5.1 GovernanceTransition

Being able to do (and see) a transition or edit an object in Change Management depends on:

1. Being a participant, which depends on the role you have.
2. The status of the object.
3. The authority on the specific transitions (Authority tab on GovernanceTransition)

In QLM there are two ways to access the governance for the object. First is to right-click the object and choose the Governance button.

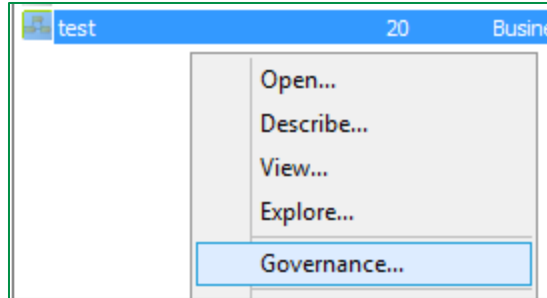
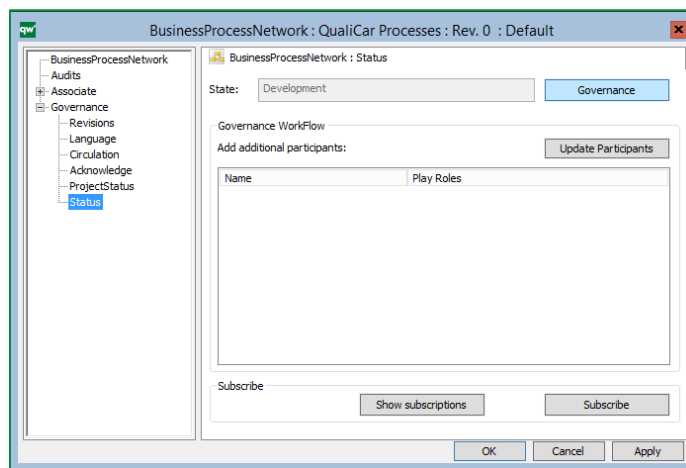

Figure 15: Open the governance status dialog right away

Or you can expand the Governance tab (click the plus in the dialog for the object), choose the status tab and click the Governance button.



N.B. If the GWE has not registered that the object is part of a workflow then you will see the "old" status tab layout.

Clicking on the Governance button will give the 'GWE current status' dialog and Governance actions shows a dialog with the possible transitions. Only persons on the participation list will get the possible actions.

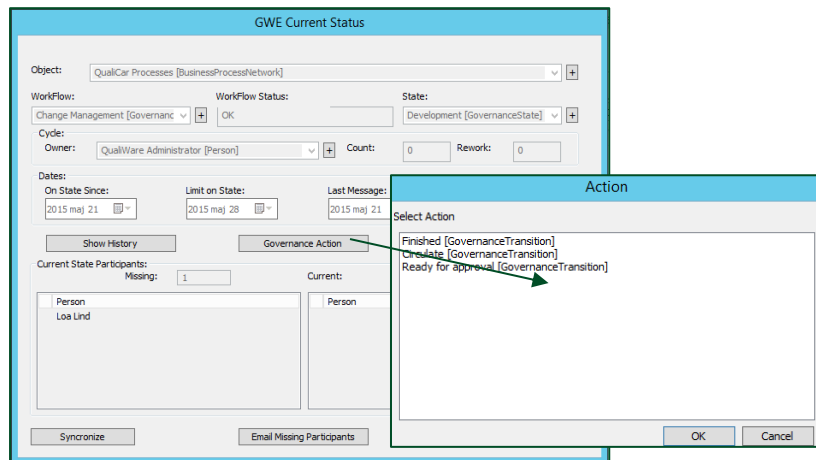

Figure 16: GWE status tab with the objects relevant governance information and change status dialog.

On the web you have a drop-down menu called Governance Actions with all the possible transitions. You can only, see transitions (and buttons) you are allowed.

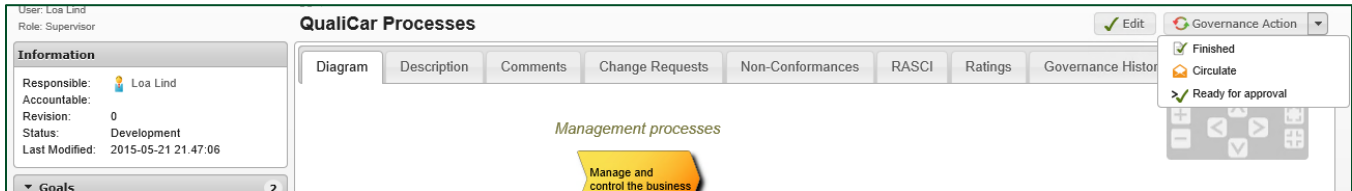

Figure 17: The Governance Action drop-down on the web for changing the status of the object

5.2 Governance History

Governance history is a log of the different transitions and actions the object has gone through.

N.B. It can also be used when an unexpected event occurs it might tell what went wrong in the Governance History and if not this can also be further researched in the QEF log.

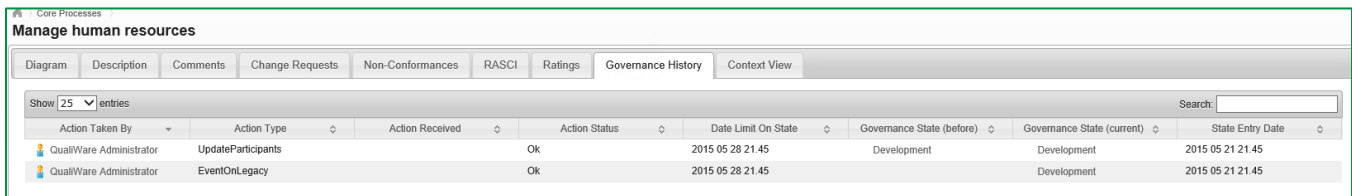

Figure 18: Governance history on the web

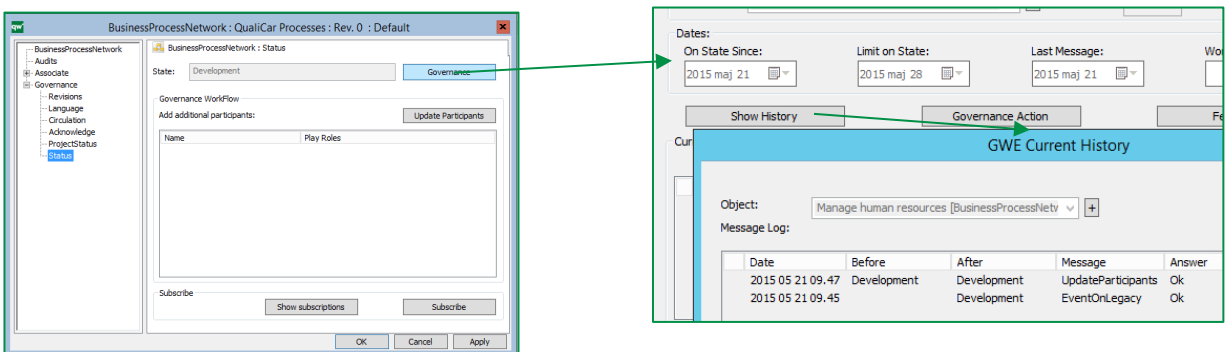

Figure 19: Governance history in QLM

5.3 Governance Features

The available features for current participants are shown on the web as buttons next to the Governance Actions.

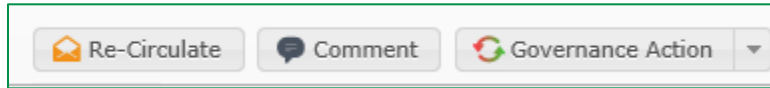

Figure 20: Available features as seen on the web

It is also possible to use the features from QLM, if it is configured in the GovernanceStateFeature object.

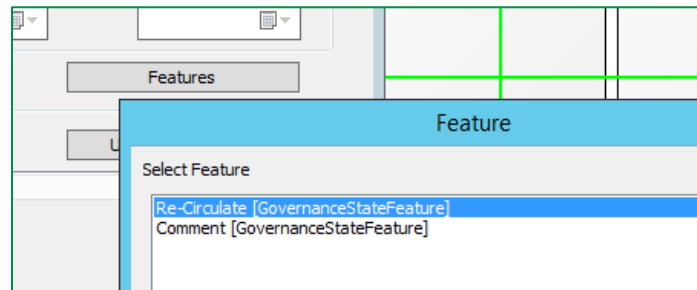

Figure 21: Available features as seen in QLM

6 Table of Figures

Figure 1: Repository setup menu in RA.....	4
Figure 2: Before creating the GWE database	4
Figure 3: After pressing "Generate Settings*" values are inserted automatically	5
Figure 4: On the left are the workflows for Collaboration and on the right are Compliance workflows	5
Figure 5: QLM buttons.....	6
Figure 6: The relevant templates for configuring GWE	6
Figure 7: The Synchronize buttons for Change Management GovernanceWorkFlow	7
Figure 8: Governance tab for a BusinessProcessNetwork (it is the same for every object registered by the GWE)	7
Figure 9: Synchronize the GWE	8
Figure 10: Dialog for setting up mail server	9
Figure 11: Setup the mail for the GovernanceWorkFlow	9
Figure 12: Filter on email domains and the two delivery options	10
Figure 13: QCL Engine Service "EmailSender"	10
Figure 14: The Change Management process	11
Figure 15: Open the governance status dialog right away	12
Figure 16: GWE status tab with the objects relevant governance information and change status dialog.	13
Figure 17: The Governance Action drop-down on the web for changing the status of the object	13
Figure 18: Governance history on the web.....	13
Figure 19: Governance history in QLM.....	13
Figure 20: Available features as seen on the web	14
Figure 21: Available features as seen in QLM	14